

# REED

## Model R5002

High Voltage Insulation  
Resistance Tester



[www reedinstruments com](http://www.reedinstruments.com)

# Table of Contents

Safety .....	3
Features.....	4
Specifications.....	4-6
Instrument Description .....	7-10
Operating Instructions.....	11-18
<i>AC/DC Voltage Measurement</i> .....	11
<i>Internal Power Source Measurement</i> .....	12
<i>Low Resistance Measurement &amp; Continuity Check</i> .....	12
<i>Measuring Insulation Resistance</i> .....	13
<i>Auto-discharge</i> .....	14
<i>Insulation Resistance Measurement Principle</i> .....	14
<i>Polarization Index and Dielectric Absorption Ratios</i> .....	14-15
<i>Use of Guard terminal</i> .....	15-16
<i>Data Hold</i> .....	16
<i>Peak Hold</i> .....	16-17
<i>MAX/MIN Value</i> .....	17
<i>Relative Value</i> .....	17
<i>Emergency Stop</i> .....	18
<i>Backlight</i> .....	18
<i>Auto power off</i> .....	18
Battery Replacement.....	18

## Safety

- Complies with IEC61010 safety measurement requirement in pollution degree 2, overvoltage category (CAT. IV 600V) and double insulation
- Do not apply more than 600V to this meter
- Do not use this meter around explosive gas, vapor, or dust
- Do not use this meter in a wet environment
- When using the test leads, keep your fingers away from the lead contacts, behind the finger guards
- Do not use this meter with any parts or cover removed
- Do not come in contact the circuit under test while taking measurements
- Do not use this meter if it is damaged or parts are exposed; look for cracks or missing plastic
- Be careful when working above 30V rms
- Discharge all circuits after measuring high voltage
- Place test leads in their proper input terminals
- Make sure all the test leads are firmly connected to the input terminals
- Make sure the insulation resistance tester is turned off when opening the battery compartment
- Do not change the battery when in a wet environment
- Do not use or store this meter in high temperatures, humidity, explosive environments, and near strong magnetic fields
- Dry this meter before storing if wet
- When not in use, set the range selector switch to the “OFF” position and remove the test leads
- Remove the batteries if the instrument is not used for a long period of time

## Features

- Insulation test range: 0.1M $\Omega$  to 60G $\Omega$
- Insulation test voltages: 500V, 1000V, 1500V, 5000V
- AC/DC voltage: 0.5V to 600V
- 200mA Continuity
- Resistance: 0.1 $\Omega$  to 6k $\Omega$
- Auto-discharge function & voltage output warning function
- Backlight level selector
- Live circuit warning symbols plus audible warning
- Live circuit detection prevents insulation test if >30V is detected
- Auto-power off function & battery check
- Time set measurement function
- Polarization index measurement (PI)
- Dielectric absorption ratio measurement (DAR)
- Auto ranging with 6000 counts LCD display and bar-graph
- MAX/MIN, PEAK, Relative Value, & Data Hold functions for AC/DC voltage measurements
- 6000 count LCD display with bar-graph

## Specifications

Operating conditions:	0 to 40°C (32 to 104°F); 80% RH
Storage conditions:	-10 to 460°C (14 to 140°F); <80% RH
Sampling rate:	2.5 readings per second
Fuse:	500mA/600V (6 x 32mm) ceramic 3AG fast blow
Zero adjust:	Automatic
Auto power off:	20 min
Power supply:	Eight (8) 1.5 (R14) batteries
Dimensions:	198 x 148 x 86mm (7.8 x 5.8 x 3.4")
Weight:	1.5Kg (3lb)

*continued ...*

Includes: One black alligator test lead, one green alligator test lead, one red alligator test lead, one red 2-prong alligator test lead, batteries, and a tool box

### DC/AC Voltage Measurement

Range: 0.5-600.0V  
 Resolution: 0.1V  
 Accuracy: AC: +1.0% reading + 5 digits (40 to 60Hz)  
                   +2.5% reading + 10 digits (61 to 400Hz)  
                   DC: +1.0% reading + 5 digits

### Insulation Resistance Measurement

Rated voltage	500V	1000V	2500V	5000V
Measuring range (Auto-ranging)	0.005-6M $\Omega$	0.005-6M $\Omega$	0.05-60M $\Omega$	0.05-60M $\Omega$
	6.01-60M $\Omega$	6.01-60M $\Omega$	60.1-600M $\Omega$	60.1-600M $\Omega$
	60.1-600M $\Omega$	60.1-600M $\Omega$	0.61-6G $\Omega$	0.61-6G $\Omega$
	0.61-6G $\Omega$	0.61-6G $\Omega$	6.1-60G $\Omega$	6.1-60G $\Omega$
Open circuit voltage	DC 500V +20%, -0%	DC 1000V +20%, -0%	DC 2500V +20%, -0%	DC 5000V +20%, -0%
Rated current	1-1.2mA (at 0.5M $\Omega$ load)	1-1.2mA (at 1M $\Omega$ load)	1-1.2mA (at 2.5M $\Omega$ load)	1-1.2mA (at 5M $\Omega$ load)

Short-circuit current: Approx 1mA  
 Accuracy: +2.5% reading + 15 digits (at 0.005 to 600.0M $\Omega$ );  
                   +3% reading + 15 digits (at 0.61 to 6.00G $\Omega$ );  
                   +4% reading + 15 digits (at 6.1 to 60.0G $\Omega$ )  
 Voltage monitor range: 5 to 6000VDC (resolution 1V)  
 Accuracy: +1.5% reading + 5 digits

*continued ...*

## Low Resistance Measurement & Continuity Check

	Range	Resolution	Accuracy
Resistance (Auto-ranging)	0.1 to 600 $\Omega$	0.1 $\Omega$	+1.5% reading + 10 digits
	6.01 to 6k $\Omega$	0.001k $\Omega$	+1.5% reading + 15 digits

Continuity Buzzer:  $\leq 50\Omega$

Short circuit Current:  $\geq 200\text{mA}$

Open Circuit Test Voltage:  $\geq 4.5\text{V}$

For service on this or any other REED product or information on other REED products, contact REED Instruments at [info@reedinstruments.com](mailto:info@reedinstruments.com)

# Instrument Description

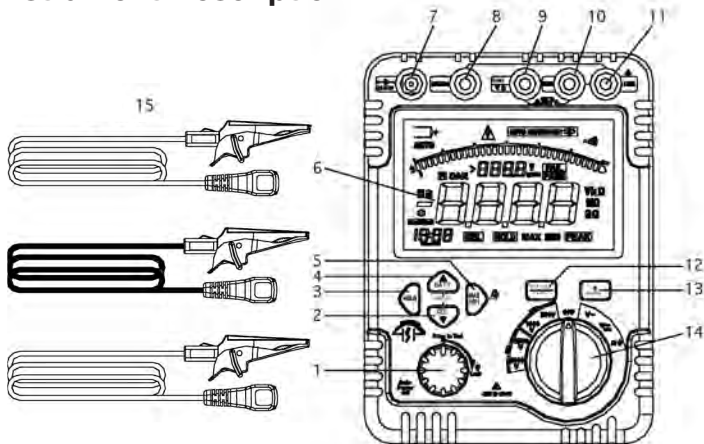

1. Insulation resistance test/lock button
2. Relative/Time-down button
3. Data hold button
4. Internal battery check/time-up button
5. MAX/MIN & Test button
6. LCD display
7. Power adaptor input terminal
8. EARTH: high resistance measurement input
9. V/ $\Omega$  input terminal & GUARD: grounding protection input terminal
10. COM & high voltage line shielding input terminal
11. LINE: 500 to 5000V high voltage output terminal
12. PI/DAR, peak voltages measurement & time clear button
13. Backlight levels button
14. Function switch
15. Test leads

## Input Terminals

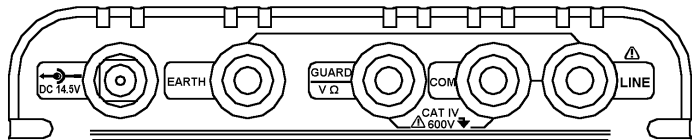

### Insulation Resistance Measurement

- LINE:** 500V to 5000V range insulation resistance measurement/high voltage line output terminal (LINE + COM: two plugs red test lead to one alligator clip)
- COM:** Return terminal for all measurements (LINE + COM: two prong red test lead)
- GUARD:** Grounding protection input terminal (black test lead)
- EARTH:** Insulation resistance measurement input terminal (green test lead)

### ACV/DCV/Low Resistance Measurements & Continuity Check

- V/Ω:** Input for voltage, low resistance measurements & continuity check (red test lead)
- COM:** Return terminal for all measurements (black test lead)



## Front Panel

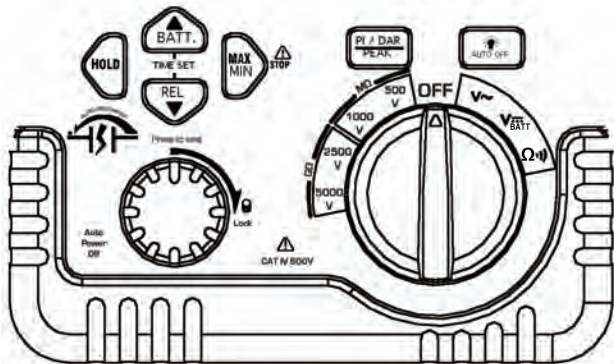

**HOLD:** Freezes current reading

**Backlight:** Turns the backlight on, makes it brighter, and turns it off

### Insulation Resistance Measurement

**TEST/LOCK:** Press and hold to test or lock on insulation resistance measurement

**Time-up:** Adjust timer up

**Time-down:** Adjust timer down

**PI:** Polarization index measurement

**DAR:** Dielectric absorption ratio measurement

**STOP:** Stop insulation resistance measurements and high voltage output

### AC/DC Measurements

**MAX/MIN:** MAX/MIN record

**PEAK:** PEAK-MAX/PEAK-MIN capture

**REL:** Relative measurement

**BATT:** Check battery power

## LCD Display

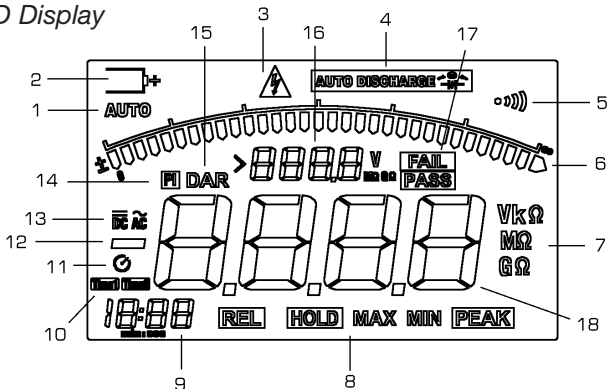

1. Auto-ranging indicator
2. Battery life indicator
3. High voltage output or >30V AC/DC voltage indicator
4. Indicator for automatically discharged
5. Continuity buzzer indicator
6. Analogue bar graph
7. Unit symbols
8. Function indicators
9. Clock
10. Timer 1 & Timer 2 indicators
11. Active timer symbol
12. Indicates for negative reading
13. AC/DC indicators
14. Polarization index
15. Dielectric absorption ratio
16. Secondary reading display
17. Check feature pass or fail
18. Primary reading display

# Operating Instructions

After pressing the TEST button under insulation measurement, the wire will generate high voltage. Do not touch it to avoid electric shock.

## AC/DC Voltage Measurement

To avoid electric shock, do not test if voltage to ground AC/DC is more than 600V, even if the line voltage is below 600V.

1. Set the rotary switch to the AC or DC position.
2. Connect the red test lead to the  $V\Omega$  terminal and the black test lead to the COM terminal.
3. Connect the test leads to the circuit under test.
4. Read the voltage value on the LCD.
5. When measuring DC voltage, if the red test lead is negative voltage, “-” will appear on the display.

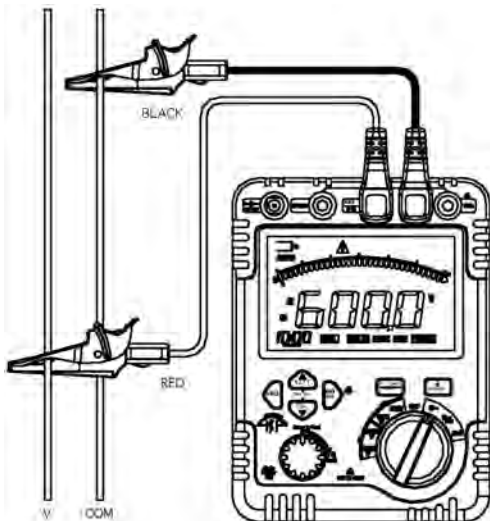

## Internal Power Source Measurement

1. Disconnect the test leads.
2. Set the switch to DC.
3. Press the BATT button.
4. Read the voltage value on the LCD.
5. After 5 seconds the meter will auto-off or press the BATT button to turn off the battery voltage function.

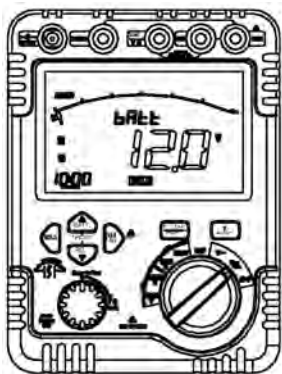

## Low Resistance Measurement & Continuity Check

Do not run this test unless AC/DC = 0V. Do not use this mode to check diodes.

1. Set the rotary switch to the  $\Omega$  position.
2. Connect the red test lead to the  $V\Omega$  terminal and the black lead to the COM terminal.
3. Connect the tips of the test leads to the circuit under test.
4. Read the resistance value on the display.
5. When the resistance of a circuit is less than  $50\Omega$ , the audible tone will sound.

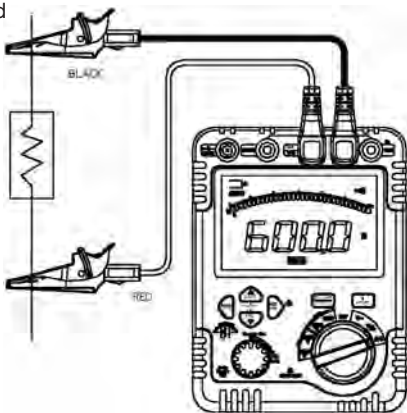

## Measuring Insulation Resistance

- Prior to testing check the circuit with a high voltage detector to be sure that there is no electrical charge
  - It is highly recommended to wear insulated gloves while taking high voltage measurements
  - Do not make measurements with the battery compartment open
  - Do not take measurements during thunderstorms
  - Be sure to connect the black Earth Cord to the Earth terminal of the circuit under test
  - Measurements cannot be made if the “>30V” live circuit warning appears or if “AUTO DISCHARGE” appears on the LCD screen along with a warning buzzer
1. Check the amount of voltage that can be applied to the circuit under test, and set the range switch to the desired insulation resistance range.
  2. Connect the black Earth cord to the Earth terminal on the circuit under test.
  3. Touch circuit with the tip of the red line probe and press the “PRESS TO TEST” button. The buzzer will sound intermittently during measurement.
  4. The measured value will display on the LCD, and it is automatically held after measurement.
  5. At any output voltage, when the tested resistance is less than  $10M\Omega$ , the testing time cannot exceed 10 seconds continuously.

**Note:** Do not touch the circuit under test immediately after testing. Capacitance stored in the circuit may cause electric shock. Leave test leads connected to the circuit and never touch the circuit until the discharge is complete.

## *Auto-discharge*

This function releases the capacitance stored in a circuit after testing. The LCD will flash “AUTO DISCHARGE” when the meter is in discharge condition and the live voltage monitor will display “0 V”. This function will be released by removing test leads 2 sec or more before discharge is complete. Set the range switch to “OFF” position, and remove test leads from the instrument.

## *Insulation Resistance Measurement Principle*

Insulation tests should only be performed on de-energized circuits.

### Continuous Insulation Resistance Measurement

Press and turn the “PRESS TO TEST” button clockwise to perform a continuous insulation resistance measurement. After testing, turn the button counterclockwise to the initial position. A beep will sound and the reading will hold on the LCD for 10 seconds.

### Timer Insulation Resistance Measurement

This is a function to automatically conduct a test at a set time (from 1 min to 15 min).

1. Press the Time-up and Time-down buttons to set the time from 1 min to 15 min.
2. To activate the timed insulation resistance measurement, press and turn the “PRESS TO TEST” button clockwise till it locks.
3. After testing, turn the button counterclockwise to the initial position. A beep will sound and the reading will hold in the LCD for 10 seconds.

## *Polarization Index and Dielectric Absorption Ratios*

Polarization Index (PI) is the ratio of a 10-minute to 1-minute insulation resistance. Polarization index = resistance value measured after 10 min (Time2)/resistance value measured after 1 min (Time1). Dielectric Absorption Ratio (DAR) is the ratio of a 1-minute to 30-second insulation resistance. Dielectric Absorption Ratio = resistance value measured after 1 min (Time2)/resistance value measured after 30 sec (Time1).

*continued ...*

1. Press the PI/DAR button to select PI or DAR Measurement.
2. The LCD will display PI & Time1/Time2 or DAR & Time1/Time2.
3. To begin measuring, press and turn the “PRESS TO TEST” button clockwise till it locks.
4. After testing, turn the button to counterclockwise to the initial position. A beep will sound and will display “PASS if the reading is PI/DAR>4, or “FAIL” if the reading is PI/DAR<1. The reading will hold for 10 seconds.

### PI standard

PI value 2 to 4 (typically3):	Considered as good insulation (older types)
PI value 1 to 1.5:	Not acceptable (older types)
PI value 1:	(Very high insulation resistance) Modern type of (good) insulation systems
PI value 1.0 or less:	Fail

**Example:** If measuring a B-class insulation material and the polarization index is 1.1, the insulating material contains too much water or is seriously polluted. The polarization index is below the minimum acceptable value and you need to repair or replace parts.

### DAR standard

DAR value 1.6 or more:	Excellent
DAR value 1.25 to 1.6:	PASS
DAR value <1.25 or less:	Fail

### *Use of Guard terminal*

When measuring a cable, the leakage current flowing on the surface of cable jacket and the current flowing inside the insulator combine and may cause error in value. To prevent this error, wind a conductive wire around the point where leakage current flows, then connect it to the Guard terminal as shown in the figure below.

*continued ...*

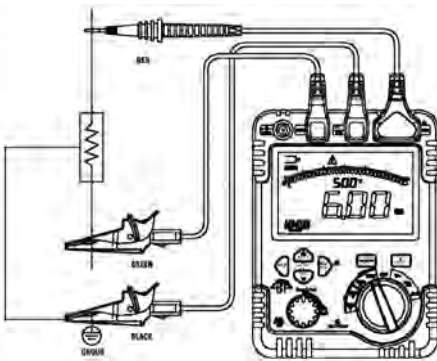

This removes the surface leakage resistance of the cable insulation so you only measure the volume resistance of the insulator. Make sure to use the Guard cord supplied with this instrument to connect the instrument to the Guard terminal.

### *Data Hold*

This function freezes the reading on the display. Press the HOLD key momentarily to activate or to exit the hold function.

### *Peak Hold*

The Peak Hold function captures the peak AC/DC Voltage from 0.5V to 600V, and can capture peaks from 10 to 100 milliseconds in duration.

1. Press the PEAK button. The symbol "PEAK" will appear on the LCD.
2. Press the MAX/MIN button to activate the MAX/MIN recording mode. The symbol "MAX & PEAK" will appear on the LCD. The screen will display and hold the maximum reading and will update only when a new "MAX" reading occurs.
3. Press the MAX/MIN button again and "MIN & PEAK" will appear on the screen. The LCD will display and hold the minimum reading and update only when a new "MIN" reading occurs.

*continued ...*



4. Press the MAX/MIN button again, and a “MAX MIN PEAK” symbol will appear on the LCD. The meter will display the present reading, but will continue to update and store the max and min readings.
5. To exit MAX/MIN-PEAK mode press the PEAK button or hold the MAX/MIN button for 2 seconds.

## *MAX/MIN Value*

Only for AC/DC voltage measurement

1. Press the MAX/MIN button to activate the MAX/MIN recording mode. The symbol “MAX” will appear on the screen. The LCD will display and hold the maximum reading and will update only when a new “MAX” reading occurs.
2. Press the MAX/MIN button again and “MIN” will appear on the screen. The meter will display and hold the minimum reading and will update only when a new “MIN” reading occurs .
3. Press the MAX/MIN button and “MAX MIN” will appear on the screen. The meter will display the present reading, but will continue to update and store the max and min readings.
4. To exit MAX/MIN mode press and hold the MAX/MIN buttons for 2 seconds.

## *Relative Value*

(Only for AC/DC voltage measurement)

The relative measurement feature allows you to take AC/DC voltage measurements relative to a stored reference value. The displayed value is the difference between the reference value and the measured value.

1. Press the REL button to store the reading currently on display. The “REL” symbol will appear on the display.
2. The display will now show the difference between the stored value and the measured value.
3. Press the REL to return to normal operation.

## *Emergency Stop*

If you are taking high-voltage insulation resistance measurement and the danger of a short-circuit arises, stop testing immediately by pressing the “TEST” button.

## *Backlight*

Press the Backlight button to select the display backlight levels and to turn the backlight on and off. The backlight will automatically turn off in 60 seconds.

## *Auto power off*

This meter enters Sleep Mode and blanks the display if left inactive for 20 minutes. To exit Sleep Mode, press any button or turn the meter ON again.

## **Battery Replacement**

When the Battery symbol appears on the LCD screen, it is time to replace the batteries.

1. Turn the insulation resistance tester to the OFF position and remove all connections from the terminals
2. Remove the screw from the battery compartment, and separate the battery compartment from the case bottom
3. Replace with 8 new 1.5V (LR14) batteries
4. Reattach the case bottom and battery compartment, and reinstall the screw



